



Stolp Starduster Corp.

Ronna Noreen Pleiman

Ronna Noreen Pleiman
Publisher

OCTOBER 1982

THIS MAGAZINE USES MATERIAL SUBMITTED BY IT'S READERS.
SOME ARTICLES OR STATEMENTS MAY NOT BE IN AGREEMENT
WITH STOLP STARDUSTER CORPORATION OR IT'S EDITOR.

TABLE OF CONTENTS

PRESIDENTS COMMENTS	2
NOTICE TO OUR CUSTOMERS	3
11 YEAR DREAM SET TO FLY HIGH	4
SHEN VALLEY 1983 FLY IN	5
PIREPS	6
15 YEARS AND 5000 HOURS ... SO FAR !	10
STARDSUTER MAGAZINE TECHNICAL SUMMARY	16
FOR SALE	19
.....	20
CLASSIFIED ADS	INSIDE BACK COVER

WE WOULD LIKE TO THANK ALL OF THIS ISSUES CONTRIBUTORS AND RESPOND TO ONE
AND ALL FOR SOME INTERESTING INFORMATION AND PHOTOS.

FRONT COVER - SA300 STARDUSTER TOO. THE PROUD OWNER/BUILDER (AND RIGHTLY
SO) IS JOE FERRARO OF WESTFEILD, INDIANA. A BEAUTIFUL AND PATRIOTIC RED,
WHITE AND BLUE COLOR SCHEME. N51JF.

BACK COVER - THE PROUD OWNER OF THIS LITTLE BEAUTY IS LOWELL SLATTER OF
FILER, IDAHO. THE COLOR SCHEME OF HIS ACRODUSTER TOO IS ORANGE WITH WHITE
AND BLACK ACCENTS.

THE EDITOR IS STILL LOOKING FOR TECHNICAL AND DEITORIAL CONTRIBUTIONS TO
THIS MAGAZINE, WHICH IS DEDICATED TO THE HOME BUILDER AND SPORT AIRCRAFT
ENTHUSIAST.

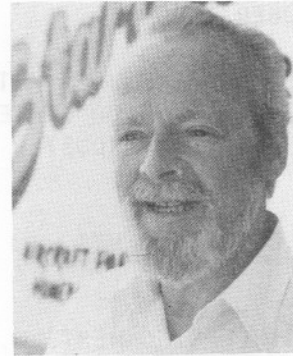

I suppose the 1982 convention at Wittman Field was a huge success for most all who attended. It was good to see so many friends and the beautiful array of Stardusters and Acrodusters.

It is with much regret and reluctance that I report the loss of a close friend, Joe Ruddy and his beautiful Round Powered Starduster Too, killed in a mid-air, in the fly-by pattern.

Before the mis-hap we had planned a new society which he was to head.

Joe was to be the president of "Round Power" for Starduster Too. Being the most qualified, he was also excited and eager to help.

There is no way to describe the loss we feel when we lose someone close to us. But we can show our respect and remember.

Starduster Corporation will begin with a perpetual "Joe Ruddy Memorial Trophy", which will be used in place of the traditional designer awards. We will inscribe the winners name on the trophy each year.

Stolp Starduster Corp.

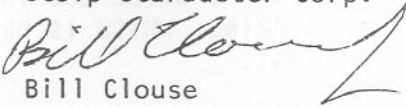
Bill Clouse

President

Hartzell Propeller
TRW Equipment Group

P.O. Box 1458
1800 Covington Avenue
Piqua, Ohio 45356
513 778-4323
Telex 288039

September 1, 1982

Beginning with shipments on October 1, 1982, TRW Hartzell Propeller will increase prices on all of its product lines. Most items will show increases between 12% and 17%, however some may fall outside of this range due to special situations.

Price catalogs will be available prior to October 1, 1982.

Thank you for your continued interest in TRW Hartzell Propeller.

Yours truly,

TRW HARTZELL PROPELLER

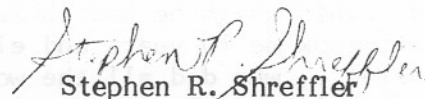

Stephen R. Shreffler
O.E.M. Sales Manager

SRS:kls

Dear Customer,

Stolp Starduster Corp. does not want to raise it's prices. The only way to avoid this situation is by reducing our expenses. Money is a very costly commodity these days, so we must eliminate our accounts receivable to put us in a better position to maintain prices.

All future orders must be prepaid by check or C.O.D. Visa and MasterCard are also accepted.

I would like to reassure you that this action does not reflect on anyones credit. It is a necessary action for us to continue to serve you. As in the past, quality products and workmanship at a competitive price.

Materials Will Be Invoiced At
Prices And Terms Prevailing At
Time Of Shipment.
Prices Subject To Change
Without notice.

11 YEAR DREAM SET TO FLY HIGH

A Portland gas station owner once dreamed of building himself an airplane. Now, nearly 11 years later, he's wheeling his dream out of his workshop and getting it ready to fly.

"Once I start something, I finish it," Americo Mazziotti says.

The brightly-painted, yellow and red "Starduster Too" biplane was being loaded onto a trailer today for a trip to Lewiston Auburn Municipal Airport hangar. There, it will acquire its wings and, after a few months of ground tests, it will take off, or so its builder hopes.

Sitting in the open-air cockpit in goggles and helmet will be 60 year old Mazziotti, a grandfather who flies so he can feel "free as a bird." Mazziotti is vice president of the Portland chapter of Experimental Aircraft Association, a group of aviation enthusiasts, and flies regularly in private planes.

His interest in aviation goes back to building model planes as a child. During World War II he trained in the Navy as a rear gunner on a dive bomber and flew in biplanes (airplanes with two supporting surfaces, one above the other). He also served on the aircraft carrier Princeton at locations all over the Pacific.

Since then, flying as a hobby has been his passion.

The "Starduster Too" is not a reproduction of a World War I vintage plane, despite its nostalgic looks. Mazziotti constructed it painstakingly from an original design by Stolps Starduster Corp., working from blueprints which he had to learn to read, rather than from a kit.

"It took me 10 years and eight months - a total of 3,840 hours," says Mazziotti, who did all the work himself in a workshop behind his Mazziotti Bros. Texaco station at Washington Avenue and Bates Street.

"For five months of the year I worked in the workshop, every evening and weekend.

"I had to learn everything as I went along - carpentry, sheet metal and electrical work." Mazziotti even took welding courses to learn how to piece together the planes hundreds of parts. "I'd get discouraged a lot; then I'd go down to the bridge and go fishing. Believe me, there is a lot of blood, sweat and tears in this plane." There's also a \$12,000 investment, considerably higher than the \$3,000 original estimated cost.

"Starduster Too" measures 20 feet from nose to tail and has a 24-foot wing span. Its fuselage is made of steel tubing covered with Dacron fabric that Mazziotti ironed on with his wife's household iron, then painted with several coats of airplane paint.

The plane has two cockpits, one in front of the other, which appear to be a snug fit for the average-size person.

The wings were carefully constructed in the cellar of Mazziotti's home on Sherwood Street.

Other portions of the project spilled over into the household, too, when winter cold prevented Mazziotti from working in his unheated workshop.

"I built the center section in my living room. My wife used to ask, "Can't you keep the tools under the bed instead of out in the room?"

Looking back on the years of work and time devoted to his unusual project, Mazziotti remarks that he's lucky to have "an understanding wife"

He expects his plane to not quite "dust" the stars at an altitude of 2,000-5,000 feet, with a speed of 110 mph.

This is not the first "Starduster Too" Mazziotti has built. Ten years ago, he and his brother Domenic built a half-scale model out of kitchen

Dear Bill,

Hope you had an enjoyable vacation at Oshkosh.

October 7,8, and 9 '83 will be the largest Shen Valley Fall Festival Fly In at Shenandoah Valley Airport, Weyers Cave, Va. ever held in the state of Virginia. This will be a joint fly in by all Virginia chapters plus some from surrounding states.

You are not only invited but requested to advertise this in your Starduster magazine and inviting all Stardusters and Acrodusters anywhere in the country. I think this will work and result to your business interest.

Reservations must be made six to eight months in advance due to the thousands of tourists here at this time of year.

The enclosed Ingleside brochure has reserved 150 rooms for EAA and they will go fast. Toll free call. This is a chance for you to really promote Stardusters.

We expect Paul, the governer of Virginia, and many aviation dignitaries. Suggest you mention it throughout the coming year. Our brochures will be sent to you. If we can announce the fact that you will attend we can really draw in the Stardusters and builders.

Please advise on this.

**For instant reservations
call toll free
800-323-4444**

Best regards,
Ed Todd

Hi Ed,

Thanks for the brochure. The event is on my calendar and I am looking forward to visiting Virginia. I have never been there and am sure it is a beautiful time of year.

Roger T. Boggs said he is just over the hill from you and will also be there. His " 300 " may be ready. I can think of several who will show up with their machines.

Bill Clouse

Take exit 58 off I-81
north of Staunton, Virginia

INGLESIDE RED CARPET INN
Route 11 North
P.O. Box 1018
Staunton, Virginia 24401
Telephone (703) 885-1201

Dear Bill,

If there is some kind of award for working the longest time on a SA 300 without finishing it --- I'll claim it !!! My plans are number 417. Of course in the interim I did have a serious operation and left a job after 26 years at it, and there is no one around to hold things to tack them easier, but I'm back at the little beauty.

I owned a 1929 OX5 Curtiss Robin that my parents gave me as a high school graduation present (1933) and which I barned stored around the southeast for quite a while. The aircraft was destroyed by wind and not much was left. I do have the airspeed indicator which I have mailed to you. Please give it to someone into antiques that do not go very fast. It came off my Robin NC928K in case anyone is interested.

A freind of mine in Augusta, Georgia, bought a partially completed SA 300 that is now flying. In looking at this aircraft I noticed a diagonal brace on the landing gear that my plans do not call for. Please sell me the latest sheet 14 of the new gear and the tube to complete the installation. Also please send me enough .025 aluminum sheet for making strips for the bottom of the seats unless that, too, has been changed.

One more thing. Please charge for an extension of my subscription to the STARDUSTER magazine. I have no idea of the expiration date so just extend or renew it.

Sincerely,
John H. Bailey, Sr.
827 Sherwood Drive
Elberton, Georgia 30635

Dear John,

Thank you for the airspeed indicator. I have passed it on to a worthy project. It now belongs to Jim and Zona Appleby of Antique Aero. They have put it in a Sopwith 11/2 Strutter, two place with a machine gun configuration.

Am not sure you have the oldest project but must be in the top ten. Your drawing and material are on the way. Your magazine subscription has been extended and is good until October, 1983.

Regards,
Bill

Dear Bill,

I just thought I'd drop you a quick note. I called just before Oshkosh talking about ordering a SA 300 wing kit. Well we still plan to, probably in 3 weeks, but we will be in and out of town, and are worried about receiving the shipment, if we order before then. Also, we want our initial payment to be a lot more than a few hundred dollars.

Questions: Uh, would you consider selling me your symmetrical wing as a kit, heh, heh? Also I am in the market for a Bendix PSH-5BH pressure carb., and would trade an unused Marvel MA 4-5.

Sandblasting:

Very little has been written about preparing steel for the application of paint! Well, gentlemen, it ain't trivial! Ten pounds of zinc chromate don't cure any amount of rust, mill scale (the black stuff), or finger prints (and body perspiration ... sweat for the Texans in the audience). All of the above are guaranteed to make that expensive paint flake off.... eventually.

Our project sat in the sea air of New Orleans for 12 years, and demanded cleaning down to the bare metal for inspection. The previous owners had daubed on about three coats of chromate, epoxy, and some other stuff I couldn't identify. These kept the underlying corrosion from getting any worse, but, was beginning to be damaged where the structure had not been sand-blasted. The tail feathers were sandblasted, given a couple coats of z-c, and there was no problem: no rust at all.

Sandblasting: it has been tedious, but necessary, I believe. If the aircraft had been completed, the flaky paint would have soon cracked under engine vibration, and a fuselage recover (or re-manufacture) would have been necessary.

But, you say, it takes a huge air compressor to drive a sandblaster. See your local air tool supplier, and he will supply you with a Speedaire that works great on 1 hp, or less, air compressor. My little blaster has about a 3/16 in. nozzle, sandbucket, and is easy (and messy) to use. Wear double paper-type filters over your face, and get a welding goggle, with a clear lens, at least. Find a gravel products dealer and use a fine sand (sold in 50 lb. bags.) Clean the 4130 until all you see is silver-grey. Before painting, rinse the metal of any oils (skin or otherwise) with paint thinner.



"Anything exciting happen while we've been away?"

BRAD ANDERSON, MASTERS AGENCY

Tom Bullington
7605 Jemez NE
Albuquerque, NM
87109

September 10, 1982

Dear Sir,

Enclosed is a check for \$12.00. Please send your catalog and subscription to " Starduster " magazine.

I am still improving my Jacobs powered Starduster Too N-3263 and as of March 82 FAA issued permanent airworthiness certificate on it. See enclosed photo taken prior to installation of 850x6 tires, winter front, etc.

I will enclose some copies of old air show pics so you can see I've always been a bi-plane " nut ". I think you have the finest of the newer bi-planes in the Starduster Too series and would not sell my airplane for any money.

I am however gradually making some changes on the ship which I feel are in order, based on experience of possible weak points of bi-planes as they have shown up on air show work through the years. This does not infer that the " Too " needs anything, just that any airplane can usually be improved upon.

I did, however, perform a test evaluation for Champion Aircraft Corp. in 1963 at the request of Mr. Brown, (then Pres. of the co.) regarding possible weak points in the then new " Citabria ". The test flights were performed on behalf of National Air Shows at Dayton Ohio and so as a result showed a number of necessary changes, all of which were incorporated in the later production airplanes, such as counter balanced elevators, longer control stick, relocated CG, longer rudder peddles, more power etc.



I would be happy, at your request, to outline a few structural and aerodynamic changes I am incorporating in my airplane, as I plan on this being my " permanent " bi-plane. This decision having been made after reviewing all the bi-planes I have flown since 1938.

The " Starduster Too " has impressed me more than any other bi-plane in current or recent production.

Sincerely yours,
Dick McPherson
" World's Oldest Flying Chicken "
Rt. 1 Box 139A
Fernandina Beach, Fla.
32034

Thanks Dick for the pictures. You have had an envious, colorful career.

I am extremely pleased that you find the Starduster Too the fine machine that it is.

I would like very much to know of the changes that you have made. We are at this time looking for some one to engineer the optimum round power for the Starduster.

Joe Ruddy volunteered and was looking forward to giving his talents to Starduster builder. But we lost this friend at Oshkosh this year.

Bill Clouse

Gentlemen,

First let me congratulate you and your staff for the fine new format of the latest " Starduster " issue. The multicolor is a good addition and the text gets better each issue. Keep up the good work.

Please remove the add in your classified section, re: the landing gear we wanted to sell. We have sold the units and it was a result of " Starduster " circulation. Thank you for your assistance.

Keep the technical articles coming and continue the excellent work.

Sincerely,
Milt Kingsland

Cont. from pg. 9

chairs and tables, shopping cart wheels and other found objects in preparation for the real thing.

Though he's never flown a biplane, Mazziotti has ridden as a passenger in the "convertibles," as he calls them, and logged thousands of hours flying other small planes on weekends, including an "Aronca Champ" World War II training plane he owns.

"I've had a lot of dreams that I was flying 'Starduster Too'," says Mazziotti, who can't wait to test its upside-down performance in loops and swoops and, he hopes, persuade his two sons and two daughters to try out riding in it -- one at a time. His wife, Mary, prefers rides in bigger planes, he says.

Asked whether he'll miss working on his "Starduster" after so many years, Mazziotti replies, "No way. Now I'll start to have some fun with it."

Dear Sir,
The "Starduster Too" has impressed me more than any other bi-plane in the field of recent production.
Albert Arnaud
158 Forest Ave.
Paramus, N.J. 07652

Dear Bill,

Finally sending you the pictures I promised a year ago at Oshkosh. Also have finished and will send M6 Airolfil "46" chord aluminum templet.

If you can use some of this in your STARDUSTER magazine, O.K. .

This project was started about 15 year ago and has approx. 5000 hrs. of work into it. Not counting getting material, sketching, etc. .

The engine is a new Franklin 220 hp. . I purchased the kit and assembled it. All the extra bosses left on the engine from previous modifications have been removed. All the connecting rods have been polished and balanced to approximately .2 of a gram. I am thinking of making new intake manifolds so I can better streamline the cowling. The mounting of the carburetor mounting box has been improved. After inspecting all the engine parts, I took about a dozen pieces and the crankshaft up to the factory and exchanged them.

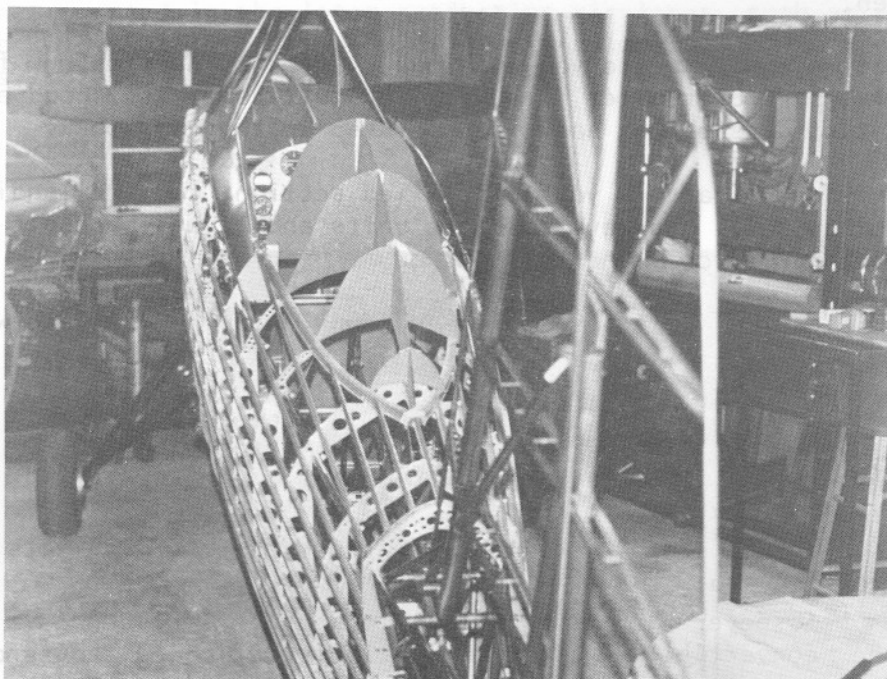

#1 Pic.: The fuselage has been narrowed 4" except at the cross piece at the top of the rear seat.

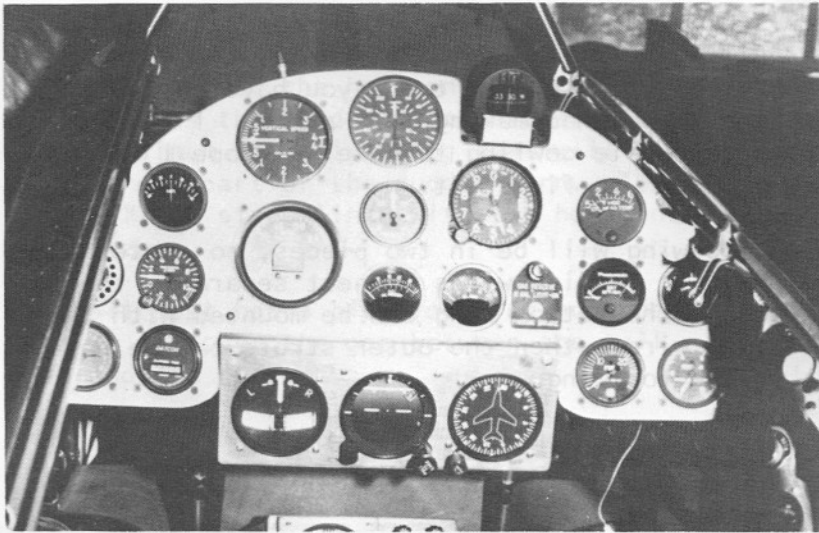

The canopy and tracks can be ejected while flying. The left side of the picture shows the tracks in place, the right side with the tracks removed.

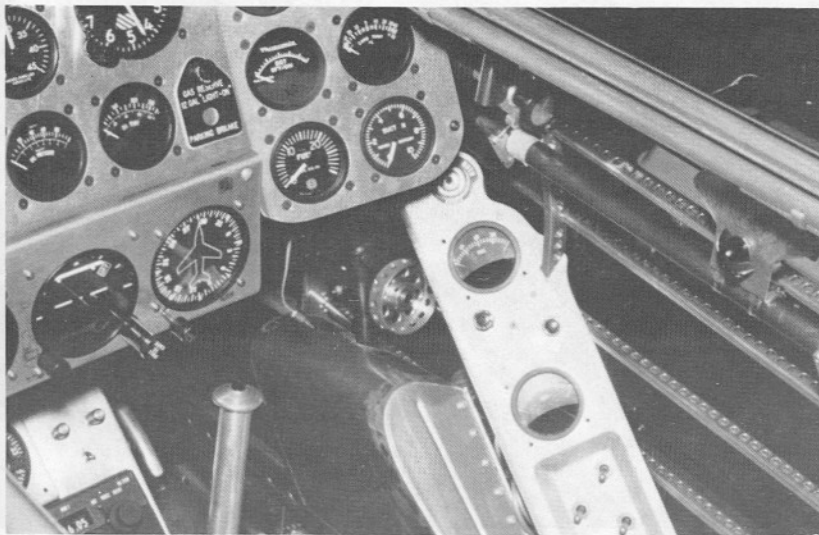

The instrument panel is tilted forward, with sides bent back. The 3 gyros can be pulled out as one unit.

The small handwheel on the right is for rudder trim. The red knob on the top to the right is for the inverted. It will switch from regular system to inverted. The black knob is for head temp., the same thing on the left side will be for exhaust temp.

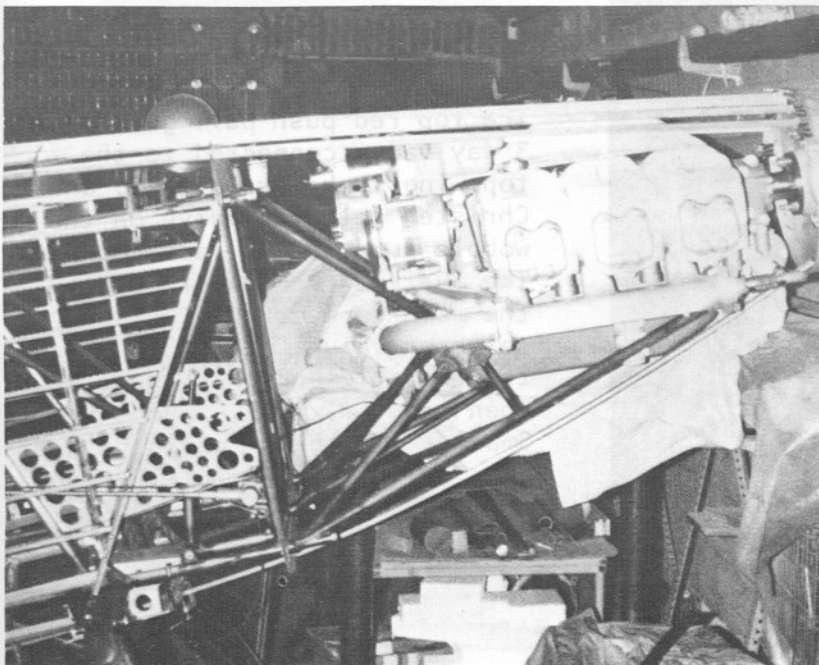

This picture shows what the cowling outline will be. The cowling goes back to the firewall on top and to the landing gear on the bottom, so that when it's removed work can be done on the front rudder pedals, etc. The cowling will be one continuous curve to the landing gear.

The fabric will go up to the aluminum former set at an angle from top of the firewall to the top of the front landing gear.

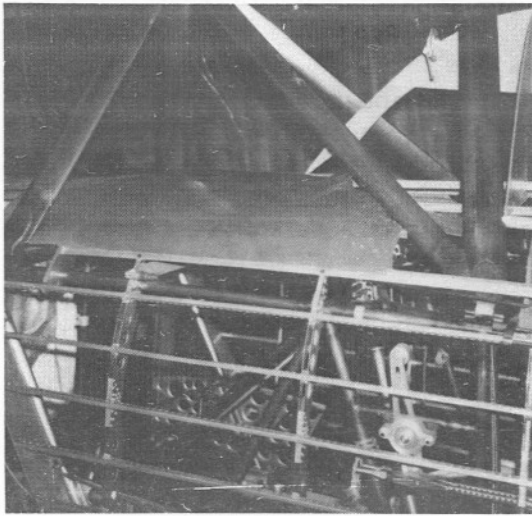

This picture shows my first compound curved piece. I built myself the equipment to do it with and found out it's another trade you have to learn. What a time I had making that piece. I still have the whole cowling to make. I hope I live long enough to finish it.

The top wing will be in two pieces, no center section. The landing wires connect separately to the cabane. The bottom wing can be mounted with the landing wires, then the outer struts can be put on, then the top wing.

The map etc. box started as a knee rest. Now I can rest my knee on the box. It serves two purposes. The stringer have approx. 4000 holes drilled in them. A savings of about 2 1/2 lbs.

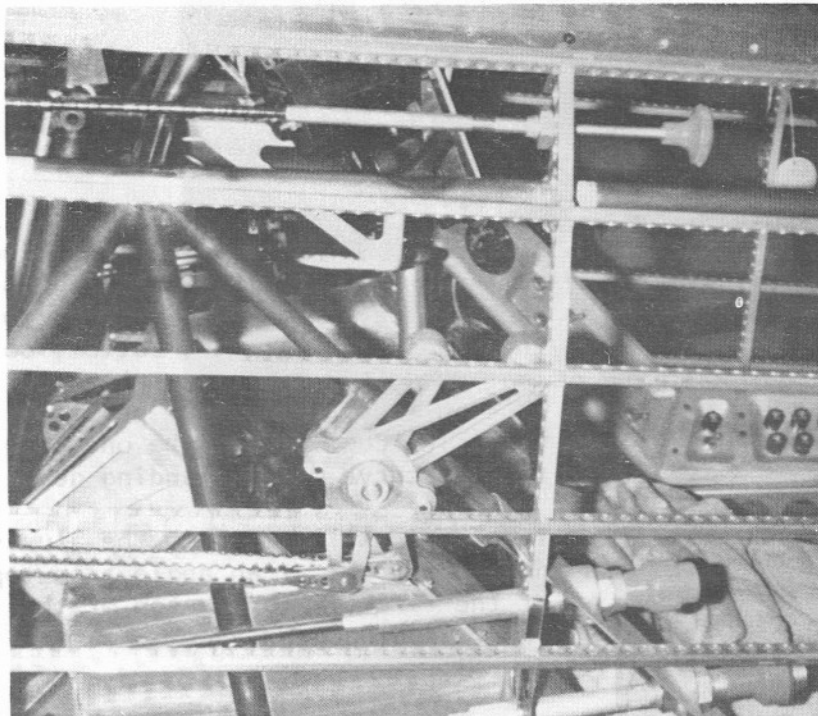
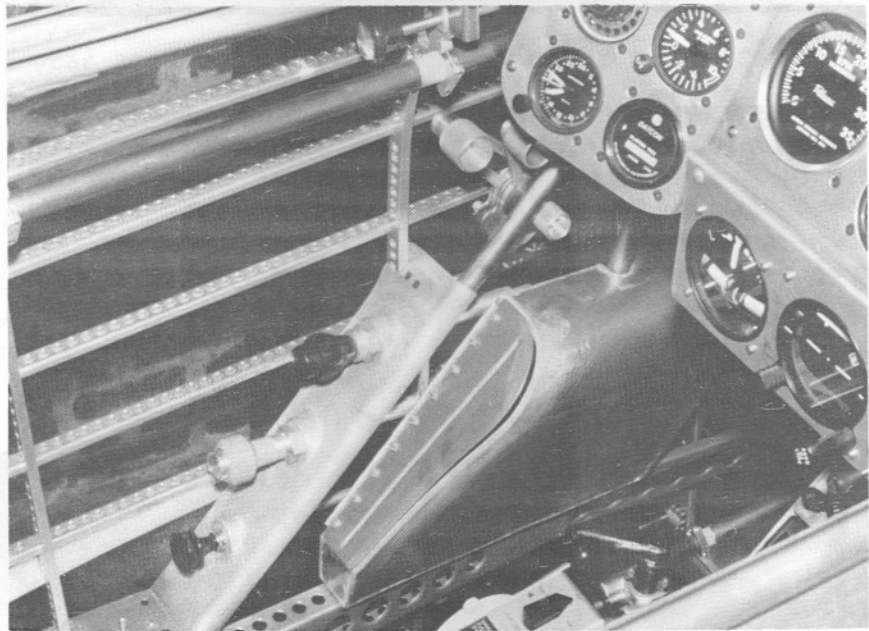

The top red push-pull goes to a 3 way valve connected to the top wing tanks, main tank, and Christen selector valve on the wobble pump in the rear cockpit. The fuel can be transferred to the main tank or the Christen selector valve. Under that is the throttle and carb. heat. Then red - mixture, blue - prop. Small red knob for cabin heat.

The tail wheel mechanism is set back in the fuselage as far as it can go. The sprocket above that, next to the tail post, is placed in the center of the horizontal stabilizer and actuates the rudder horn thru a special stiff chain. The only thing that will show is the rear part of the rudder horn. The rest will be streamlined with the horizontal stabilizer.

The tail post has a piece of aluminum snapped onto it to cover the gap between the tail post and the rudder.

The rudder hinges go inside the rudder and an aluminum piece of tubing with steel pin crimped in the proper place hold the rudder in place. The same thing done to the elevators.

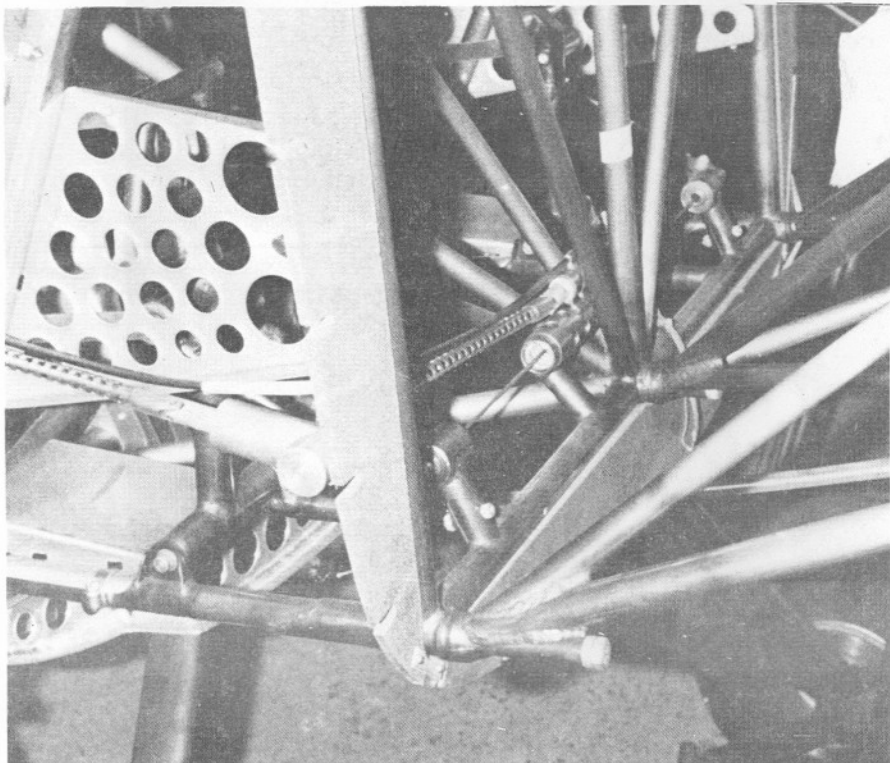
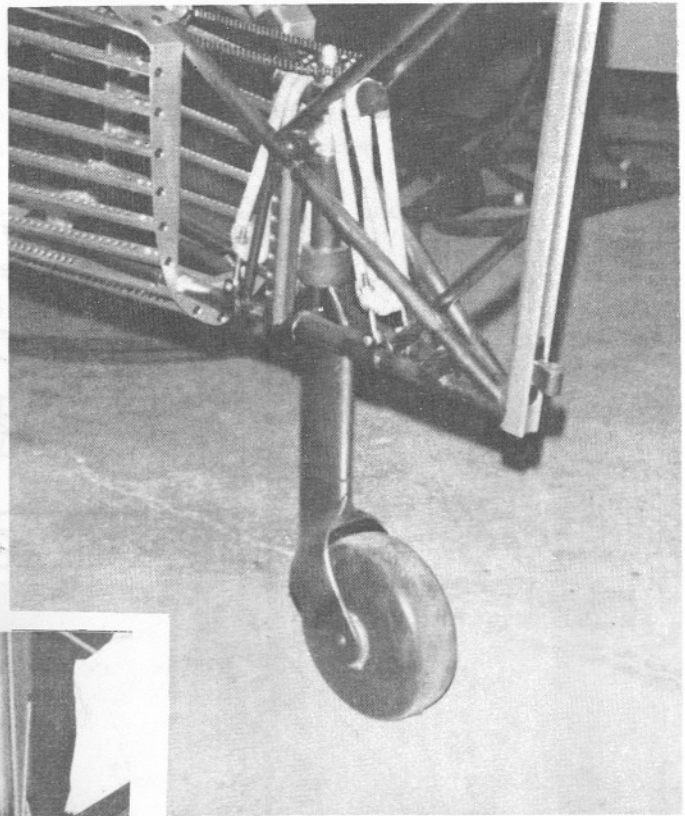

This picture shows the engine mounts mounting points.

The top wing front cabane is mounted to a similar piece on top of the fuselage. This takes the shear out of the bolts on the motor mount.

Also shown is the rudder trim neck. On top of the neck is a small cable housing with cable that goes back to a pointer at the trim wheel in the rear cockpit.



A special mounting bracket was made for the brake calipers and welded to the landing gear leg, allowing the axle to be shortened by 1 5/8 inches and placing the gear leg close to the inner wheel bearing.

The brake line runs inside the gear leg.

Of all the crazy changes I have made, the only thing I recommend other project builders to do is the following :

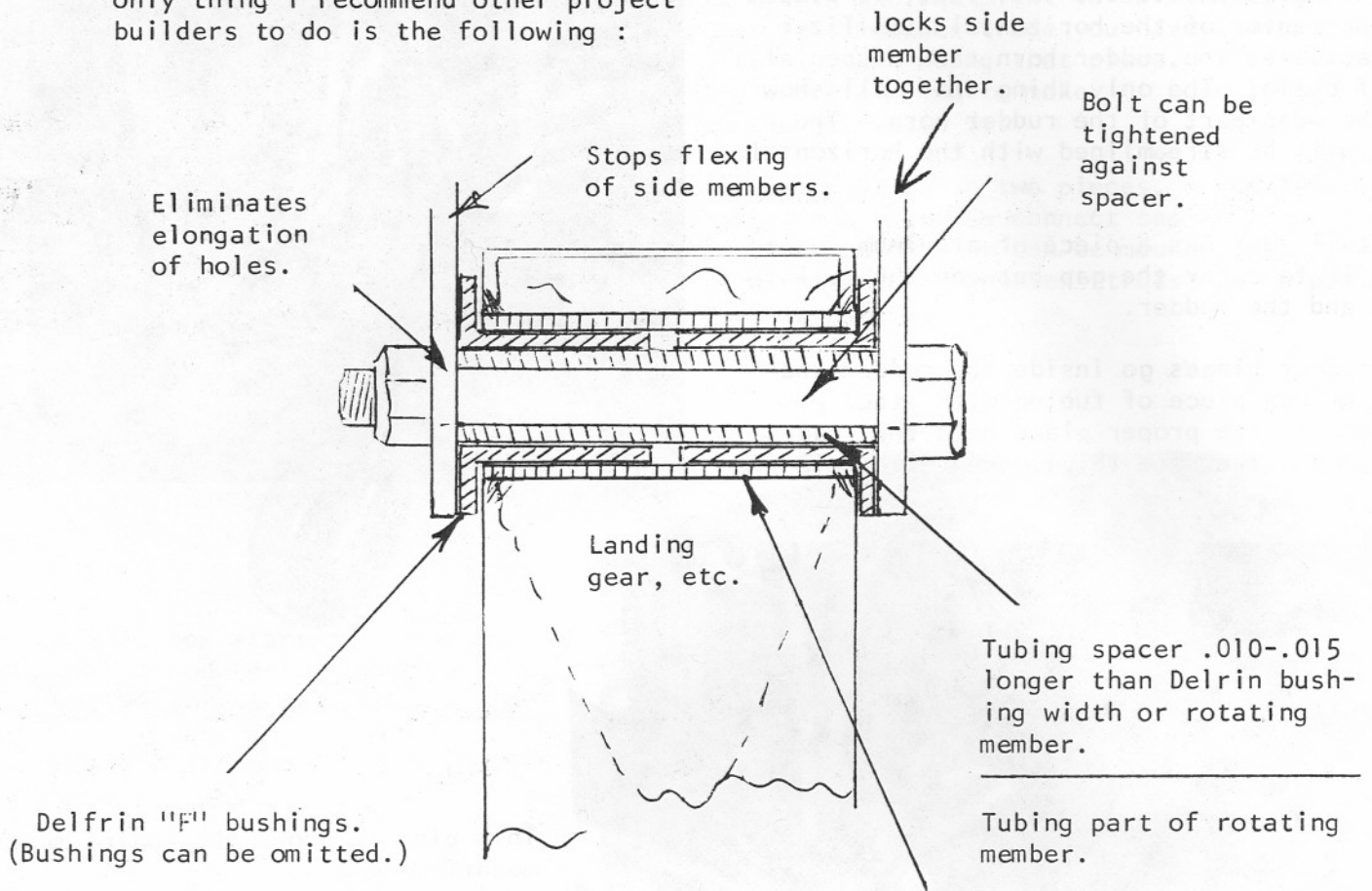

All rotating members in this project are made like the above sketch.

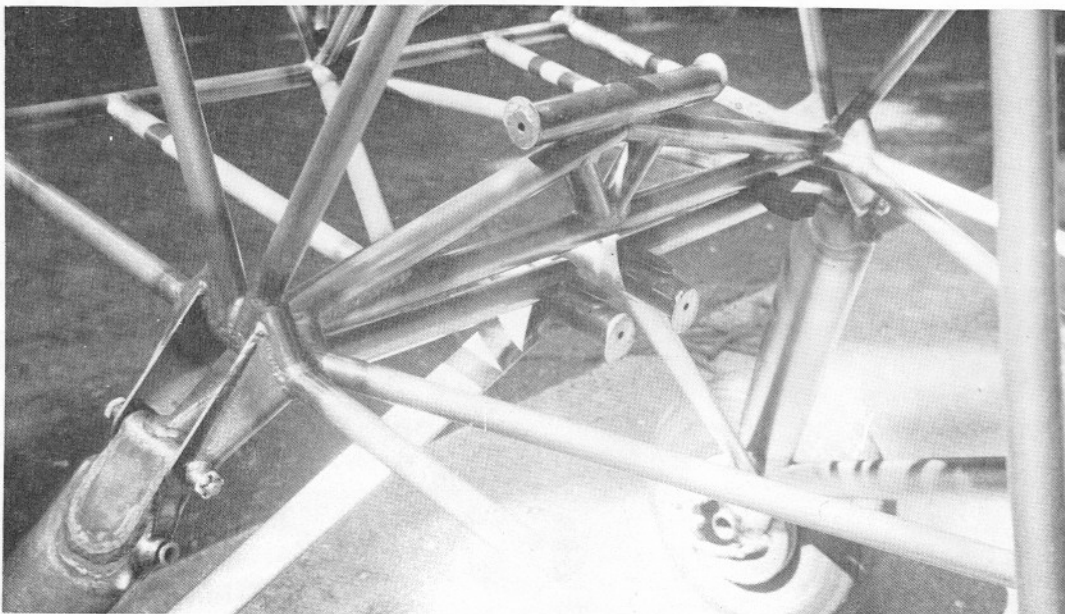

The shock ring mounting has been reversed.

See digram on page 18.

Dear Bill,

Enclosed is a picture of my Starduster Too. It has been completely rebuilt, and at last I have found an intercom that works. I am using the Sigtronic 400 with the David Clark 1040. It works like a charm.

The girls holding up the wings are my daughters Janette and Jesette, they are both learning to fly.

10360 AIA cruises 130, wt 1300 - 1800.

Sincerely,
Brian Power Waters
The flying P-W Ranch
Kennersley Farms
Church Hill, Maryland
21623



We would like to thank Doug Smith of La Habra, Ca. for his generous contribution to the STARDUSTER magazine. He has taken his time to compile a technical summary (beginning on the following page) of the STARDUSTER which can be used by our readers for easy reference to specific articles of our past issues. Thank you again.

STARDUSTER MAGAZINE - TECHNICAL SUMMARY 1978 - 1982

Aerolite Glue	April	1981	(11)
Aileron Revision, SA 750 (Sheet 38)	January	1978	(14)
Aileron Bay fillet draining, SA 300	April	1982	(17)
Aileron Bell Crank	April	1980	(25)
Alternator Installation	July	1981	(5)
Aluminum Sheet Edging Tool	October	1979	(7)
Antenna Installation	April	1982	(18)
Baggage Door	October	1979	(10)
	July	1981	(12)
Battery Holder	January	1978	(11)
Bill of Sale	August	1982	(i)
Cabane Strut Revision	April	1980	(14)
	October	1980	(10)
	October	1981	(21)
Canopy: Plexiglass Construction	July	1981	(8)
Sliding w/frame	July	1981	(17)
Cleveland Brakes	April	1981	(23) (28)
Control Stops	October	1979	(8)
	July	1981	(12)
Credit	July	1979	(7)
Dope	January	1978	(19)
	July	1978	(27)
	April	1982	(16)
Electric Schematic, external plug	January	1979	(14)
Engines: Installation I	April	1980	(3)
	July	1980	(9)
	October	1980	(13)
Break In	January	1982	(11)
Mounts	July	1979	(15)
Round	October	1981	(23)
Franklin	October	1980	(11)
	January	1981	(11)
Lycoming 10-360	July	1978	(12)
Exhaust Stack Installation	July	1979	(9)
Fabric Covering:	April	1980	(11)
Refinishing	July	1980	(3)
	October	1980	(3) (8)
	January	1981	(12)
Fiberglass	July	1980	(17)
Foot boxes in firewall	October	1981	(14)
Fuel Gages (Float)	October	1978	(11)
Fuel lines	July	1978	(5)
Fuel Pressure Loss	January	1982	(13)
Fuel Shutoff Bracket	August	1982	(15)
Fuel System Standards	August	1982	(17)
Fuel Tank Venting	April	1978	(6)
	July	1978	(12)
	April	1979	(7)
	July	1979	(29)
	July	1980	(15)
	January	1981	(29)
	October	1981	(12)
	January	1982	(20)
Fuselage Construction	January	1980	(4)

STARDUSTER MAGAZINE - TECHNICAL SUMMARY 1978 - 1982 (cont)

Gasahol	October	1980	(6)
Gel Cel Batteries	October	1978	(5)
Installation	January	1979	(10)
Upright Mounting	October	1979	(5)
Guest Record & Agreement	August	1982	(ii)
Horizontal Tail Revision, SA 750 (Sheet 4)	April	1978	(14)
Horsepower Speed & Rate of Climb	April	1978	(3)
I Strut Installation, SA 750 (Sheet 37)	July	1981	(15)
Installing Instruments	January	1981	(3)
	April	1981	(9)
Intercom	October	1978	(6)
Landing Gear: Spring Aluminum Gear	October	1978	(15)
Lightening	October	1979	(13)
Alignment	July	1980	(14)
Frame Modification Required	October	1981	(9)
SA 750 Safety Cable (Sheet 3)	April	1981	(14)
Frame Modification	January	1982	(22)
Liability - Homebuilts	January	1979	(13)
Locking Nuts	January	1981	(28)
Nitrous Oxide Injection	July	1979	(15)
Paint over paint, chemical match	April	1982	(11)
"Imron" Paint	January	1980	(11)
Propellers - Sensenich	January	1980	(12) (13)
Rigging	April	1982	(7)
	August	1982	(7)
Rudder Pedal Tension	October	1979	(15)
Rudder Pedals	January	1981	(14)
	July	1981	(12)
Seat Installation	October	1979	(14)
	January	1981	(14)
Seat Belt	October	1979	(6)
	January	1982	(16)
Shipping Information	January	1978	(8)
	July	1981	(7)
Shock Cord Installing Tool	January	1978	(6)
Technique	July	1978	(28)
Smoke System	January	1981	(15)
	October	1981	(24)
Solar Cells	July	1978	(13)
	October	1978	(6)
Slave Strut, SA 300	April	1980	(13)
	October	1980	(26)
SA 300 Drawing additions	July	1979	(13)
Tension - Struts	April	1978	(10)
Throttle Quadrant Mounting	April	1981	(19)
	April	1982	(24)
Trunions	October	1979	(5) (16)
Tube Cutting, Paper Template	January	1981	(10)
Weight Balance	April	1979	(17) (18)
SA 300, SA 750	October	1981	(15) (16)
Wing - Construction	January	1979	(3)
2nd Installment	April	1979	(8) (25)
Wings - Design Explanation	January	1978	(3)
"X" Wing, Starduster II	April	1982	(14)

The original drawing (serial # 403) was like this.

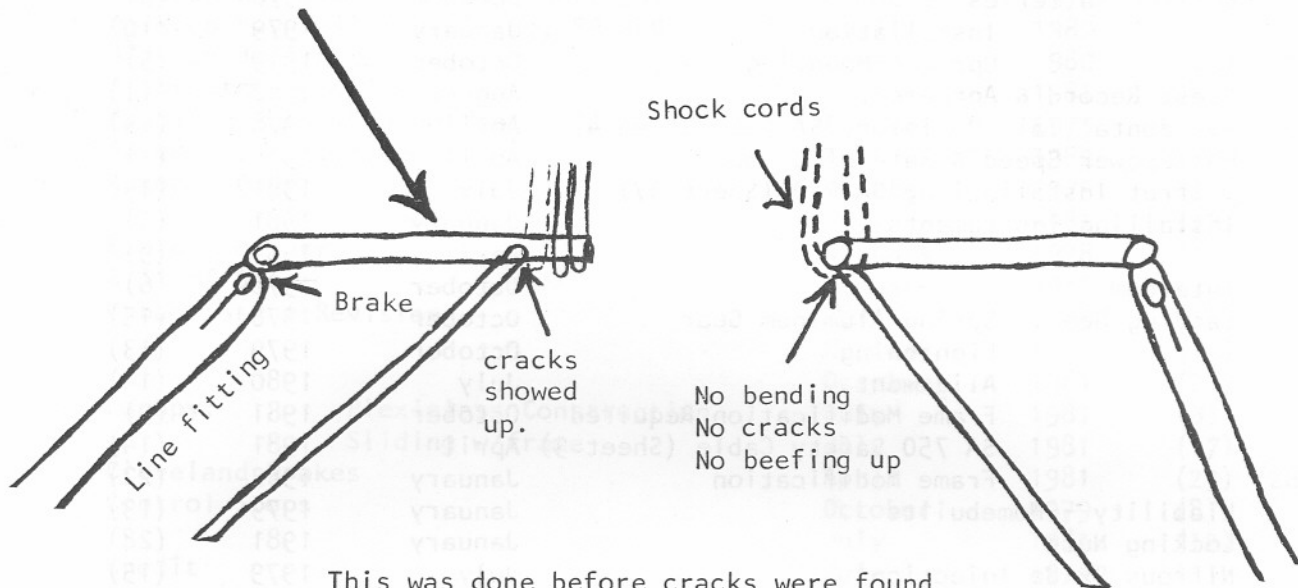

This was done before cracks were found and changes made to the drawings.

Arnold !!! I am nothing less than super impressed. I would never have beleived it if I had'nt seen it with your photos.

Your patience, skills, and imagination really show through. 4000 holes debured and polished to save 2 1/2 lbs., incredible !

It is with pleasure that we put this in the STARDUSTER as a special lay-out. It should encourage a lot of the builders and inspire them too.

I am impatient to see it a OSHKOSH.

Ye Ole Ed.

FOR SALE

STOLP-ADAMS SA-100 "STARDUSTER", semi-completed ("on the wheels") with 150 HP Continental engine and const. speed full feathering prop.

The following are complete:

Fuselage (inc. fairing longerons), empennage, landing gear, engine mount, firewall, wing struts, brake and rudder pedals, fiberglass turtleback, seat frame, wheels/tires, tailwheel, stick and rudder controls and instrument panel.

Wings are 95% complete (needs metal leading edges). Has been OK'd for covering by FAA.

PRICE: \$3500 Firm
M.A. Chilcoat
Monterey Park
213-280-9636



Dear Bill,

Thanks for the cap. Don't remember where this picture was taken but it still looks the same. Only now it has a brand new C-90 Continental in it. My wife says we should sell it now as we got to many planes. I really want to keep it forever but I've flown it only 10 or 20 hours in the last three years. The P-51 and T-6 occupy all of my time. I will need \$15,000 for it now if anyone were to want a very special aircraft. We have run a complete aerobatic sequence on it and it is FAA approved for most all maneuvers such as loops, rolls, snaps, spins, hamerheads, Cuban 8's, etc.

I know you are not in the business of retailing other peoples air-planes, but anyway this one is available.

Say hi to Lou and his lovely wife for me. See you at Osh.

Bill Clark
Clark Motor Company
1080 East College Ave.
State College, PA. 16801
814-234-4321

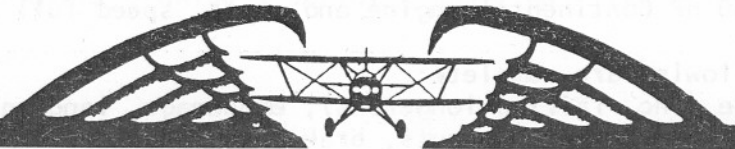

\$5000⁰⁰

OR BEST OFFER!

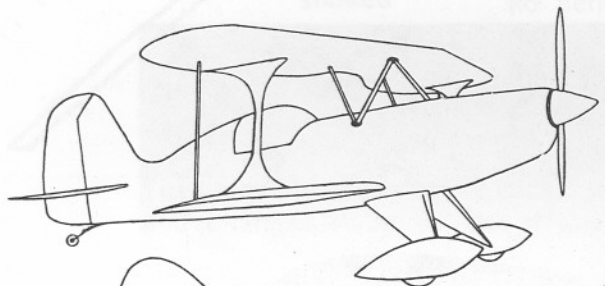
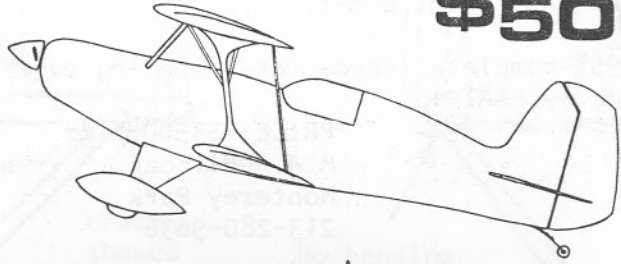

**2-PLACE
STARDUSTER
TOO**

(206)

525-4033

75% Complete. Fuselage on Gear
Upper wings ready for cover.
Lower wings need to be re-built,
Most parts to finish.



**VAN
ZANTEN**
1763 17TH AVE NE SEATTLE 98105 525-4033
**UNIVERSITY
DIST**

A4A 1ST RUN OUT

LYC * 0360 * 180 HP

Most parts yellow tagged
need starter ring gear
all other parts checked
and ready for assembly

Classified Ads

ADVERTISING CLOSING DATE: JANUARY 1, APRIL 1, JULY 1, OCTOBER 1.
CLASSIFIED ADVERTISING RATE: \$3.00 PER COLUMN INCH - MINIMUM CHARGE \$3.00
MAKE CHECKS PAYABLE TO STOLP STARDUSTER CORPORATION. THANK YOU.

STARDUSTER TOO --
WINGS AND CENTER SECTION READY FOR COVER.
ALL STEEL IN SHIPPING TUBES. TURTLE BACK.
QUALITY WORKMANSHIP.
MAKE OFFER.
(714) 365-1862

EXCELLENT STARDUSTER TOO PROJECT FOR SALE.
80 % COMPLETE. FULL CANOPY. 0-435 ENGINE
PHONE (206) 525-2067

STARLET SA500
SER # N89JB
T.T. AIR FRAME 20 HOUR ENG. SMOH BY AIR FORCE
'01 - 125 G.P.U. CONVERTED - REBUILT APRIL 1982 - RED AND WHITE - \$5000.00 CASH - FIRM
BUS. (805) 824-4359
RES. (805) 824-4351

STARDUSTER SMOKE SYSTEM REDESIGNED AND IMPROVED
NEW LITE WATE 12 VOLT PUMP. ONLY \$295.00 COMPLETE.

ORDER BY PHONE
(714) 686-7943

STARDUSTER TOO
DYNAFOCAL LYC. ENG.
MOUNT. NOSE COWLING
2 WINDSHIELDS
BEST OFFER - PHONE
(301) 758-2622
NO COLLECT CALLS

PADDING FOR COCKPIT COAMINGS --1-1/4" O.D. x 7/16" I.D. SOFT RUBBER PADDING. INSTALL OVER SMALL DIA. METAL TUBING AND COVER WITH LEATHER OR PLASTIC. EXCELLENT CRASH PROTECTION FOR THE HEAD.
ONLY \$6.95 FOR 6' LENGTH.
ORDER FROM " STARDUSTER "

STARDUSTER SMOKE PUMP AVAILABLE SEPARATELY FOR YOUR OWN SMOKE SYSTEM ... LIGHT ... LIGHT ... LIGHT ALSO VERY SMALL. ONLY \$49.50 FROM STARDUSTER

#844 CHRISTEN MANUAL FUEL PUMP SYSTEM. THE STANDARD OF THE INDUSTRY. IN STOCK IMMEDIATE DELIVERY. ORDER FROM " STARDUSTER ".
ONLY \$395.00

CHRISTEN INVERTED OIL SYSTEMS.....
#801-4 BASIC SYSTEM FOR 4-CYLINDER LYCO ENGINES. \$275.00

#801-6 BASIC SYSTEM FOR SIX CYLINDER LYCO ENGINES \$295.00

ORDER FROM STARDUSTER

#811-A CHRISTEN PUMP KIT... FOR 4 AND 6 CYL LYCOMING ENGINES.
ONLY \$85.00 FROM STARDUSTER CORP.

HOSE AND FITTING KIT NEEDED TO COMPLETE YOUR INVERTED OIL SYSTEM.
FOR 4 CYL. LYCO \$297.00
FOR 6 CYL. LYCO \$310.00
ORDER FROM STARDUSTER

NEW WINGS FOR STARDUSTER TOO. 23012 AIRFOIL. BETTER PERFORMANCE INVERTED. FASTER AND LIGHTER AILERONS. AVAILABLE READY BUILT ONLY FROM STOLP STARDUSTER CORPORATION.
\$6000.00 READY FOR COVER

BUY YOUR AIRPLANE NEEDS FROM STOLP STARDUSTER CORPORATION. UNDER NEW MANAGEMENT. NEW OWNER, BILL CLOUSE. A GOOD GUY TO DEAL WITH. WE NOW TAKE VISA FOR YOUR CONVENIENCE. ORDER BY PHONE (714) 686-7943.

YOUR ORDERS WILL RECEIVE OUR PROMPT ATTENTION. AS ALWAYS, QUALITY PRODUCTS AND WORKMANSHIP AT A COMPETITIVE PRICE.

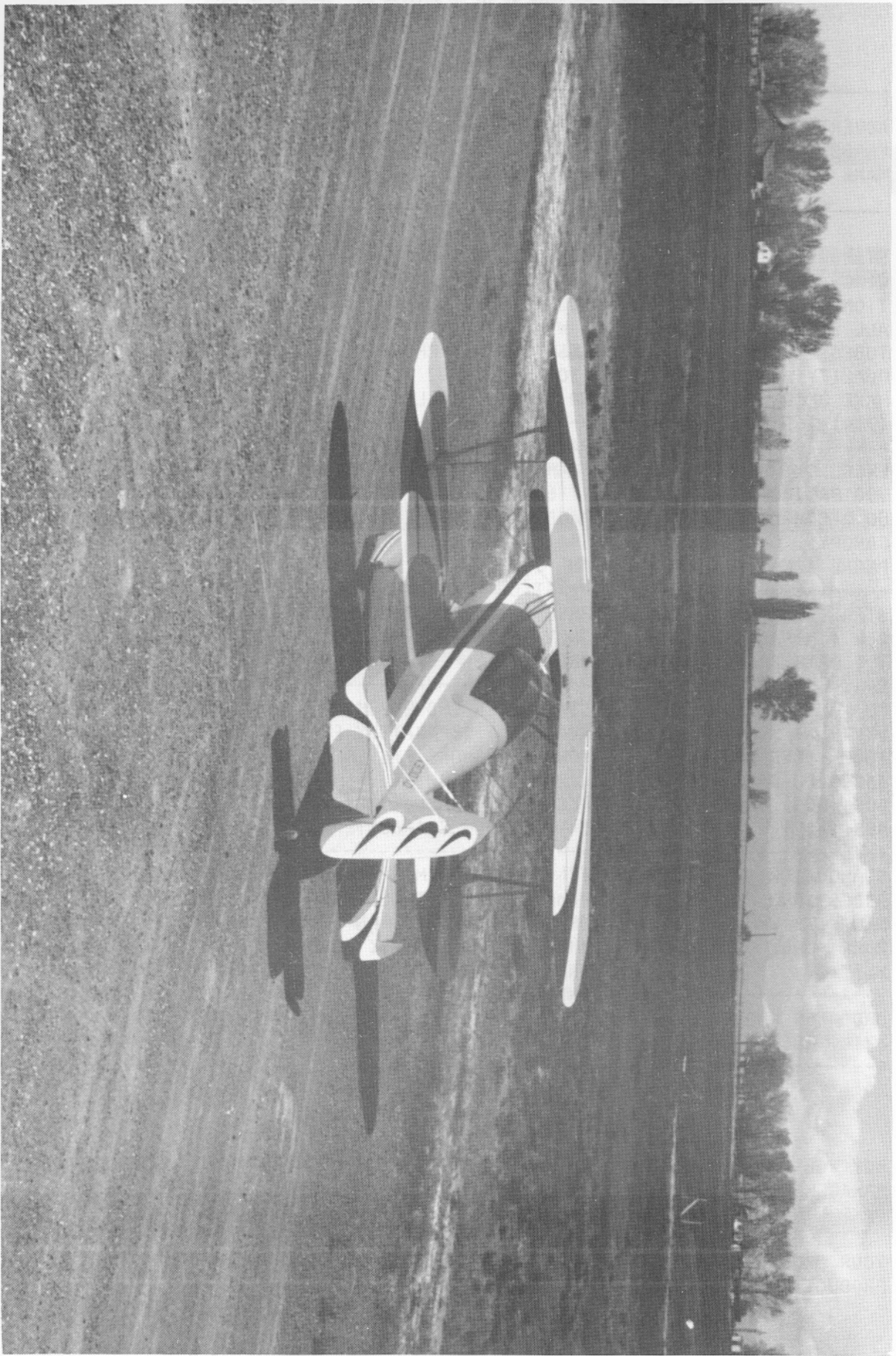

0
0
L
ER
-ER
R
YDA
ER
L